

HAMLET[®]

EXCELLENCE IN VISION

DS900

**3G, HD, SD & CST WAVEFORM,
VECTOR, AUDIO AND PICTURE MONITOR
WITH EYE PATTERN AND SIGNAL GENERATION**

OPERATOR'S HANDBOOK V1.2

© 2011 Hamlet Video International Ltd. All rights reserved

This handbook contains proprietary information of Hamlet Video International Limited and may not be copied in whole or in part nor its contents disclosed to any third parties without the express written consent of the company.

Corporate Head Office

Hamlet Video International Limited.

Maple House, 11 Corinium Business Centre, Raans Road, Amersham, Bucks HP6 6FB England.

Main Line: +44 (0)1494 729 728, Fax Line: +44 (0)1494 723 237, Free phone (UK): 0500 625 525

E-mail: service@hamlet.co.uk Web site: www.hamlet.co.uk

Hamlet USA

Sencore, Inc. 3200 W Sencore Drive, Sioux Falls SD 57107, U.S.A. Phone: (605) 339-0100 Fax: (605) 339-7032 Toll Free: 1-800-SENCORE (736-2673) or 1-866-4-HAMLET (426-538)

Email: service@sencore.com Web site: www.hamlet.us.com

IN CORRESPONDENCE CONCERNING THIS INSTRUMENT
PLEASE QUOTE THE SERIAL NUMBER PRINTED ON THE
LABEL AT THE SIDE OF THE UNIT

CONTENTS

GENERAL INFORMATION

List of figures	3
Warranty	4
Safety and EMC	5
Product disposal instructions	5
Overview	6
Case view	7

GETTING STARTED	8
------------------------	---

OPERATING INSTRUCTIONS

Waveform menu	10
Vector menu	11
Audio menu	12
Cursor menu	14
Logger menu	15
Alarm menu	16
Data menu	17
Display menu	18

OPTION MODULES

Option 1	19
Option 2	20
Option 3	21
Generator	24
Audio	28

Remote control:	29
------------------------	----

Additional functions

Presets - Setting and Recalling	30
Factory Reset	30
Power source	30

TECHNICAL SPECIFICATION	31
--------------------------------	----

Troubleshooting	33
SD Serial Digital Basics	34
HD Serial Digital Basics	39
Composite Basics	44
Useful Websites	47
Contact details and customer support	47
Internal battery	48

FIGURES

Fig 1	Case View	7
Fig 2	Typical Display	9
Fig 3	Waveform Menu	10
Fig 4	Vector Menu	11
Fig 5	Audio Menu	12
Fig 6	Audio Scales	13
Fig 7	Cursor Menu	14
Fig 8	Logger Menu	15
Fig 9	Alarm Menu	16
Fig 10	Data Menu	17
Fig 11	Display Menu	18
Fig 12	Eye cursor measurements	21
Fig 13	Eye diagram	21
Fig 14	Eye clock recovery	22
Fig 15	Closing eye	22
Fig 16	SD Serial Digital Basics	37
Fig 17	625 Field Blanking	38
Fig 18	525 Field Blanking	38
Fig 19	HD sample structure	40
Fig 20	HD embedded audio	42
Fig 21	PAL Basics	45
Fig 22	NTSC Basics	46

GENERAL INFORMATION

WARRANTY

This product is manufactured by Hamlet Video International Ltd and is warranted to be free from defects in components and factory workmanship under normal use and service for a period of one year from the date of purchase.

The Hamlet DS 900 is covered by “Absolute Care” warranty – providing 4 year cover (subject to warranty registration)

FREE EXTENDED WARRANTY

The warranty period can be extended to two years by registering the instrument on the Hamlet web site

<http://www.hamlet.co.uk/serv.html>

TERMS AND CONDITIONS

During the warranty period, Hamlet Video International Ltd will undertake to repair or at its option, replace this product at no charge to its owner when failing to perform as specified, provided the unit is returned shipping prepaid, to the factory or authorised service facility.

No other warranty is expressed or implied. Warranty shall not be applicable and be void when this product is subjected to:

1. Repair work or alteration by persons other than those authorised by Hamlet Video International Ltd in such a manner as to injure the performance, stability, reliability or safety of this product.
2. Misuse, negligence, accident, act of God, war or civil insurrection.
3. Connection, installation, adjustment or use otherwise than in accordance with the instructions in this manual.

Hamlet Video International Ltd reserves the right to alter specifications without notice. This warranty does not affect the statutory rights of the UK customer.

GENERAL INFORMATION

SAFETY COMPLIANCE

This product is manufactured and tested to comply with **BS EN 61010-1 : 1993**
Safety requirements for electrical equipment for measurement, control and laboratory use.



EMC COMPLIANCE

We, Hamlet Video International Limited, Maple House, 11 Corinium Business Centre, Raans Road, Amersham, Bucks, HP6 6FB, England, declare under our sole responsibility that the product **HAMLET DS900** to which this declaration relates is in conformity with the following standards:

EN50081-1 Generic emissions standard for light industrial applications.

EN50082-1 Generic immunity standard for light industrial applications.

Following the provisions of EU EMC directives 89/336/EEC and 92/31/EEC.

NOTE. During the EMC certification of this product, shielded cables were used.
We recommend that they be used in operation.

PRODUCT DISPOSAL INSTRUCTIONS

B2B COMPLIANCE REG NO.
WEE/GJ0146QT

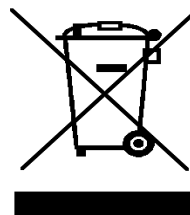

The symbol shown above and on the Hamlet DS900 means the product is classed as Electrical or Electronic Equipment and should not be disposed with other commercial waste at the end of its working life. The Producer Registration Number above, WEE/GJ0146QT proves that Hamlet are formally registered with a legally approved Compliance Scheme. The Scheme we are registered with is called "B2B Compliance".

B2B Compliance takes on the legal responsibilities of the reporting on, and the collection and treatment of, all WEEE that Hamlet Video International Limited is obliged for - and ensures that the appropriate recycling targets are met on this WEEE

The Waste of Electrical and Electronic Equipment (WEEE) Directive (2002/96/EC) has been put in place to recycle products using best available recovery and recycling techniques to minimise the impact on the environment, treat any hazardous substances and avoid the increasing landfill.

Product disposal instructions for business users.

Business users in the EU should contact their Hamlet DS900 supplier to arrange for its return to Hamlet head office in the UK, who will safely dispose of it and ensure that this Hamlet DS900 is not mixed with other commercial waste for disposal.

OVERVIEW

The Hamlet DS900 is a 1U high, half rack width 3G, HD, SD and Composite capable waveform and picture monitor, with vectors and embedded audio monitoring, supporting 3G level A and level B mapping. Plug in options are available to add 3G,HD & SD EYE patterns, composite inputs, 3G, HD, SD and Composite test pattern generation with embedded audio and AES/Analogue audio inputs/outputs with optional Dolby decoding.

With four input modules, it will show waveform displays of all four inputs in a quad-split display.

It is controlled by three touch-screen TFT LCD displays on the front panel, full colour 2" diagonal with 220 x 176 pixel resolution. There is an Ethernet port for remote control and waveform downloads, using any web browser in a Java equipped computer.

MODULES AVAILABLE

Four input module slots are available, plus a separate generator output slot slot and an internally fitted audio card slot.

- Option 1** Sdi input module, SD/HD/3G standards and audio de-embedding.
- Option 2** Composite input module, currently in development.
- Option 3** As Option 1, but with the addition of an EYE display.
- Generator** CST/SD/HD/3G generator, with embedded audio, not yet made.
- Audio** Adds AES and analogue audio input and outputs, with optional Dolby decoding, currently in development.

The DS900 displays the waveforms and pictures on the centre front panel screen and also has a high resolution DVI-I output for an external monitor, XVGA 1024 x 768 @ 60Hz.

All the standard displays are produced, including H and V Mag, Line Select, Component Parade, Filter Parade and Bowtie. The very low power consumption allows it to be used in the field from an external 12V supply.

There are also displays of four channels of audio and a vector audio phase display. The unit contains a high specification audio de-embedder, which displays on the audio bar graphs and outputs analog stereo audio to a front panel mounted headphone jack.

The serial digital signal itself is analysed to give on-screen readouts of the various digital parameter errors and signal strength in the top of screen status bar.

Measurement cursors are provided to allow amplitude and timing differences to be measured between two points on the waveform display and to provide vector phase and amplitude on the vector display.

Remote control software allows all functions to be controlled from a personal computer and for waveforms to be downloaded to a computer for display and storage.

CASE VIEW



Fig 1

GETTING STARTED

UNPACKING

The Hamlet DS900 is shipped from the factory in a specially constructed packing case. Exercise caution when unpacking the unit to prevent damage to the case finish. Examine the unit carefully for damage, which may have occurred during shipment, if severely handled.

POWER REQUIREMENTS

The Hamlet DS900 should be powered from the supplied adaptor, or a regulated supply of 12VDC of at least 2 Amps rating, to the 4 pin XLR power socket.

SIGNAL AND CONTROL CONNECTIONS

The video input connection is made to the module input BNC sockets, which are internally terminated at 75 ohms. The output BNC sockets provide an equalised output of the input feed.

The Generator module main output BNC is SDI video, the secondary BNC can output composite video, black and burst, tri-sync or input a genlock sync signal.

The external reference (Black and Burst or Tri-Sync) is internally terminated at 75 ohms.

An external digital or analogue XVGA monitor should be connected to the DVI-I socket. The standard is XVGA 1024x768 @ 60Hz.

PREVENTATIVE MAINTENANCE

The Hamlet DS900 should be visually inspected and cleaned every one year of operation.

CAUTION. The display screens are made from polycarbonate, which may soften if cleaned with some organic solvents. Do not allow water to get inside the equipment case.

The internal clock battery will need replacing every 5 years approximately with a CR2032 type.

GETTING STARTED

1. Connect an appropriate video feed to the Input A option input BNC.
2. Connect a monitor to the external DVI-I connector.
3. Connect the supplied 12V power adaptor output to the rear XLR socket.
4. Apply AC mains (100 - 250VAC) to the power adaptor.
5. The unit will now power up within four seconds.
6. The DS900 remembers all the setting when it was previously used.

TYPICAL DISPLAY

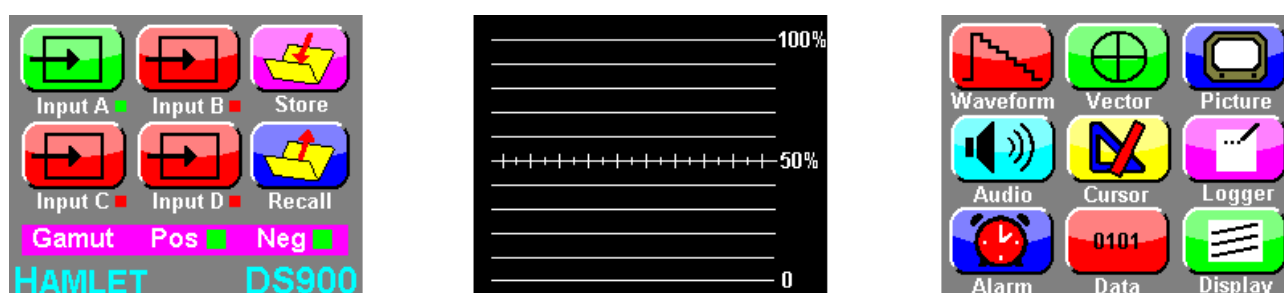

Fig 2

The left touch-screen selects the required input and is used to store and recall user configurations. The Gamut area shows level errors in the selected input signal.

POS Lights if the low pass filtered Y signal is high by 3% or more.
NEG Lights if the low pass filtered Y signal is low by 1% or more.

The centre touch-screen displays a small version of the main output, either waveforms or pictures as selected. It is also used for vertical and horizontal waveform shifting, by dragging the display to the required position against the graticule.

The right touch-screen controls the DS900 operation via a simple menu structure. The TOP LEVEL menu is shown here.

OPERATING INSTRUCTIONS

WAVEFORM MENU

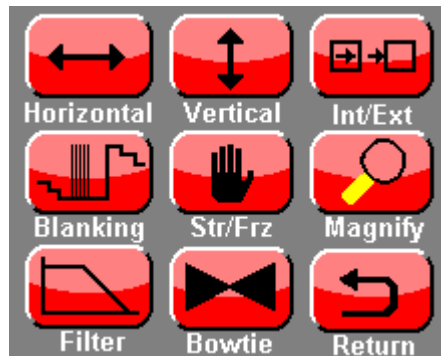

Fig 3

All modes are displayed on the main output status bar at the top of the screen.

The waveform display can be moved horizontally and vertically using the centre LCD touchscreen.

Horizontal Toggles the timebase range between H, 2H, YCrCb parade, RGB parade and HMag. In HD HMag range, the graticule major divisions are 200nS apart.

Vertical Toggles the timebase range between V, 2V, Line Select and VMag. The centre LCD touch screen controls the line number selection.

Int/Ext Selects internal reference, external reference or HFT. This automatically switches between internal and external reference to easily show timing errors.

Blanking Blanks out the horizontal blanking area (TRS, audio, aux data etc).

Str/Frz Toggles the display persistence between frame rate, infinite and freeze mode.

Magnify Toggles the gain between x1 and x2 values.

Filter Toggles the filter between FLAT and LOW-PASS.

Bowtie Toggles between NORMAL, (Y-U) and (Y-V) displays.

Return Takes you back to the top menu.

OPERATING INSTRUCTIONS

VECTOR MENU

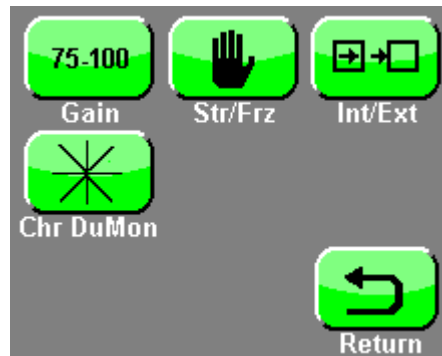

Fig 4

All modes are displayed on the main output status bar at the top of the screen.

- 75-100** Toggles the vector gain between 100% vectors, 75% vectors and x 2 gain.
- Str/Frz** Toggles the display persistence between frame rate, infinite and freeze mode.
- Int/Ext** Selects internal reference, external reference or HFT. This automatically switches between internal and external reference to easily show timing errors.
- Chr DuMon** Selects the special Chroma Du Monde graticule and gain. This is only operational in HD and 3G video standards.
- Return** Takes you back to the top menu.

OPERATING INSTRUCTIONS

AUDIO MENU

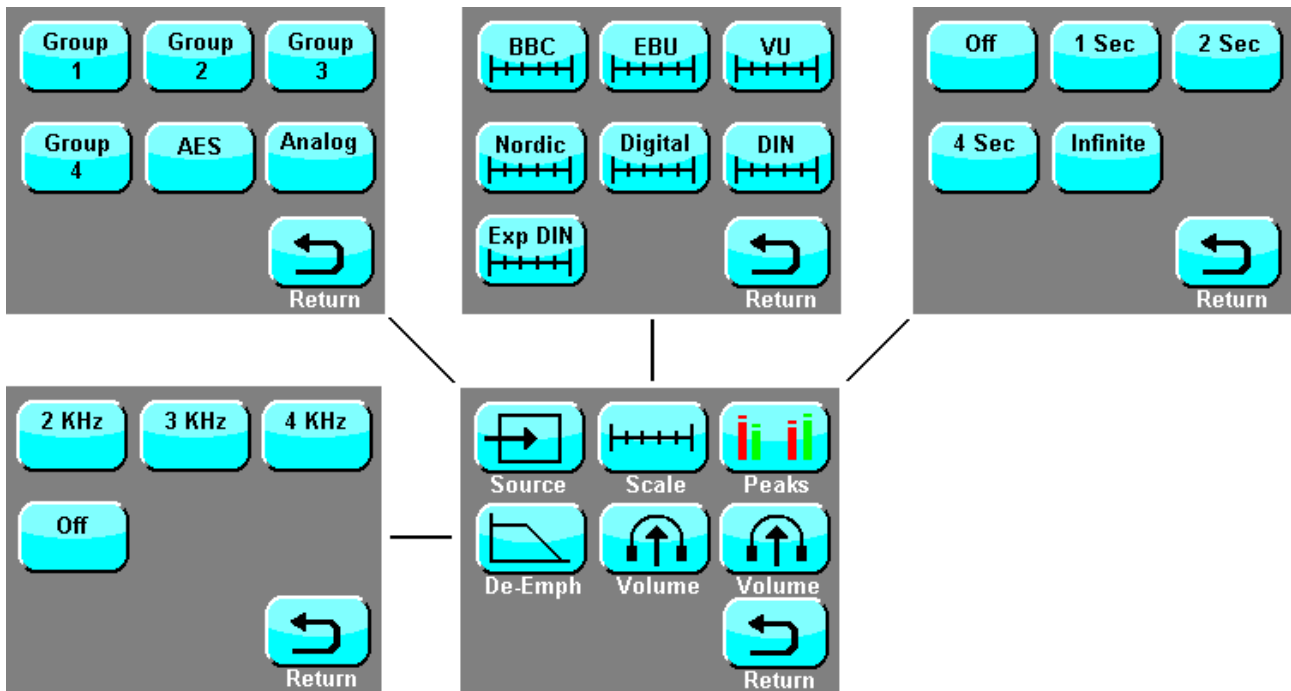

Fig 5

- Source** This selects the audio input, as per the sub-menu above.
- Scale** This selects the displayed audio scale and ballistics, as per the above menu.
- Peaks** This selects the displayed audio bar graph peak hold characteristics.
- De-Emph** This selects the audio de-emphasis required.
- Volume** This adjust the audio output level from the front panel stereo jack socket.
- Return** Takes you back to the top menu.

OPERATING INSTRUCTIONS

AUDIO SCALES

AUDIO SCALES

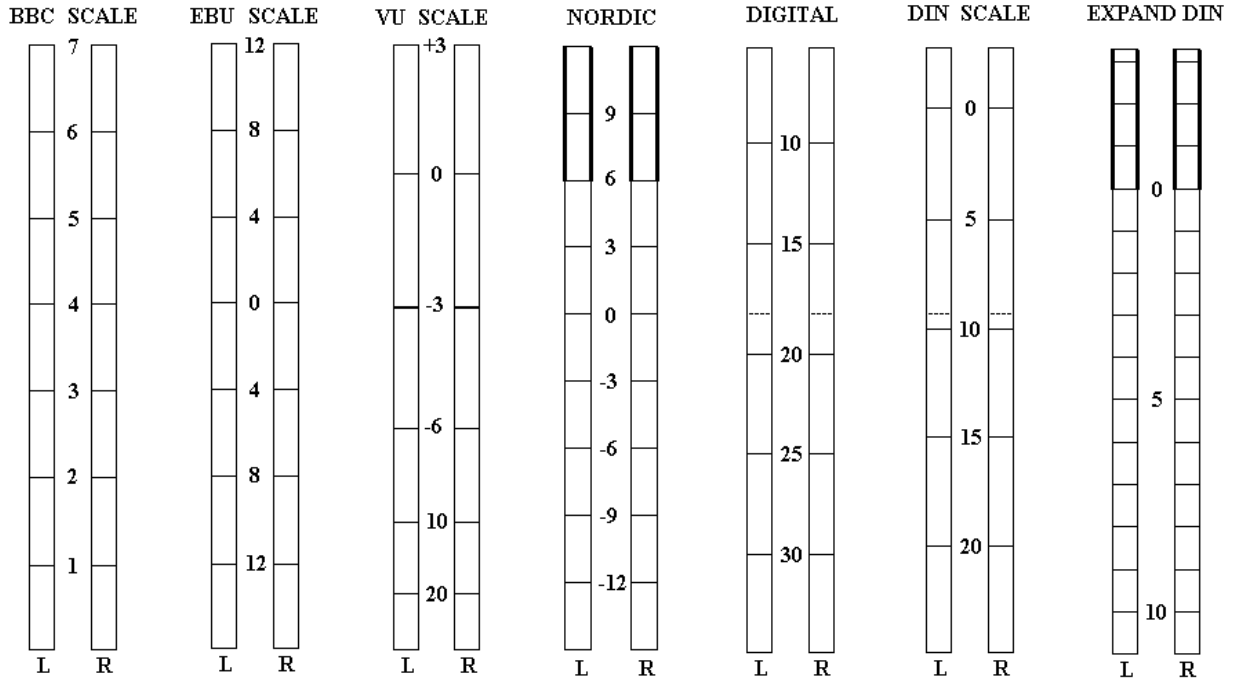

Fig 6

OPERATING INSTRUCTIONS

CURSOR MENU

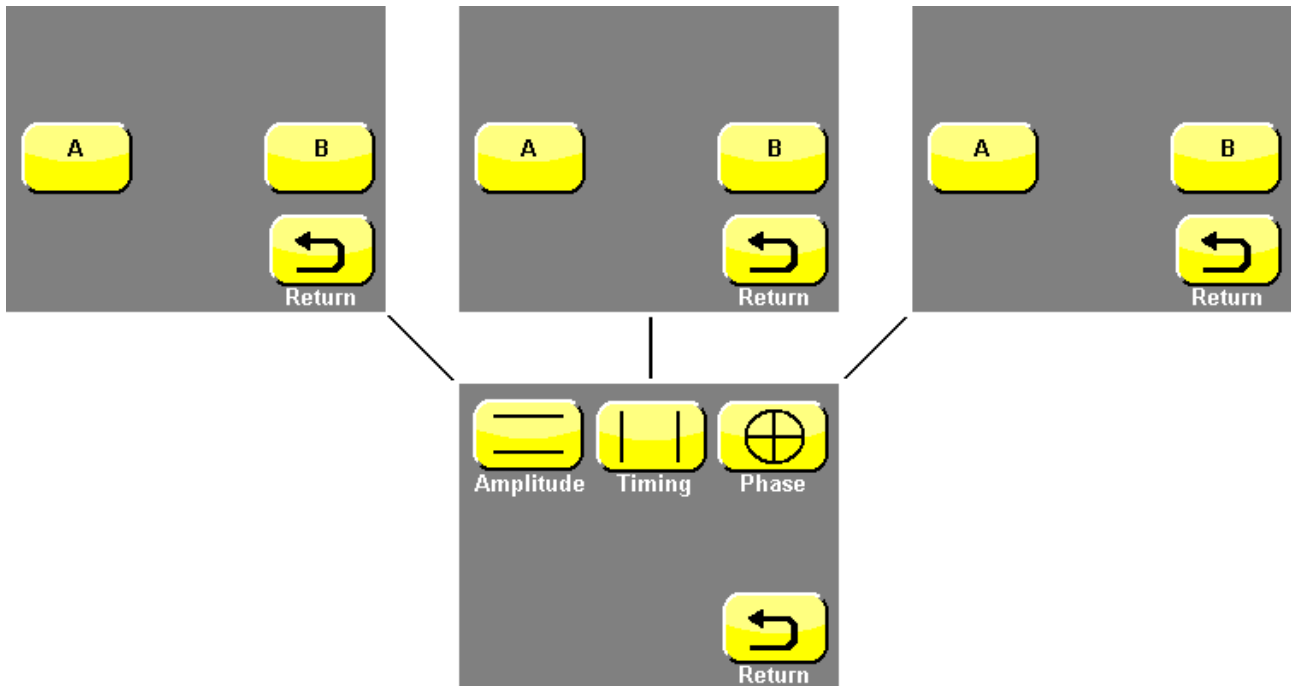

Fig 7

Amplitude
appropriate

The Red "A" and Green "B" amplitude cursors are moved by pressing the sub-menu icon and moving the cursor using the centre LCD touch screen. The amplitude corresponding to each cursor in mV is displayed in the main output status area, together with the difference between the two values.

Timing

The Red "A" and Green "B" timing cursors are moved by pressing the appropriate sub-menu icon and moving the cursor using the centre LCD touch screen. The time corresponding to each cursor is displayed in the main output status area, together with the difference between the two values.

Phase

The Red "A" and Green "B" phase cursors are moved by pressing the appropriate sub-menu icon and moving the cursor using the centre LCD touch screen. The intersection of the cursors represents a radius, measured from the centre, and a phase angle. The phase angle is taken as 0 degrees at the 9 o'clock position. The radius and angle at the intersection are displayed in the main output status area.

The time corresponding to each cursor is displayed in the main output status area, together with the difference between the two values.

Return

Takes you back to the top menu.

OPERATING INSTRUCTIONS

LOGGER MENU

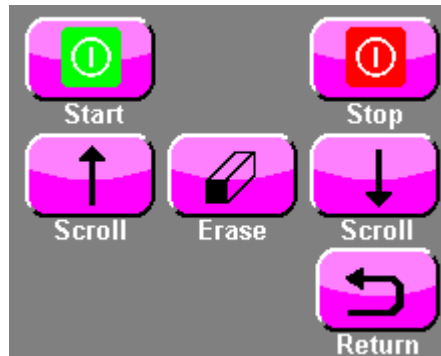

Fig 8

- Start** Starts the logger. Stores the time of occurrence, the video standard and type of all errors that have been enabled in the top level Alarms menu.
- Stop** Stops the logger.
- Scroll Up** Scrolls up the list of logged errors displayed on the main output status bar. Says "End of Log" when at the top of the list.
- Erase** Erases all logged errors.
- Scroll Down** Scrolls down the list of logged errors displayed on the main output status bar.
- Return** Takes you back to the top menu.

The log can be downloaded to an external computer.

OPERATING INSTRUCTION

ALARM MENU



Fig 9

These alarms can be set individually. When set and an error of that type occurs, they will have the following effects:

If the logger is running the error will be logged

If the logger is not running the error count will be displayed in the main output top status bar in Data mode and an audible warning will sound.

- | | |
|-----------------|--|
| Illegal | Detects illegal values in the input video (3FFh and 000h). |
| Gamut | Detects out-of-gamut values in the input video (+3%, -1%). |
| Unlock | Indicates that the DS900 is not locked to the input video. |
| ANC Data | Detects illegal values in the ancillary data packets of the input video. |
| Y CRC | Detects errors in the luminance CRC of the input video |
| C CRC | Detects errors in the chrominance CRC of the input video. |
| Line | Detects line numbering errors in the input video. |
| TRS | Detects errors in the EAV and SAV values in the input video. |
| Return | Takes you back to the top menu. |

OPERATING INSTRUCTIONS

DATA MENU

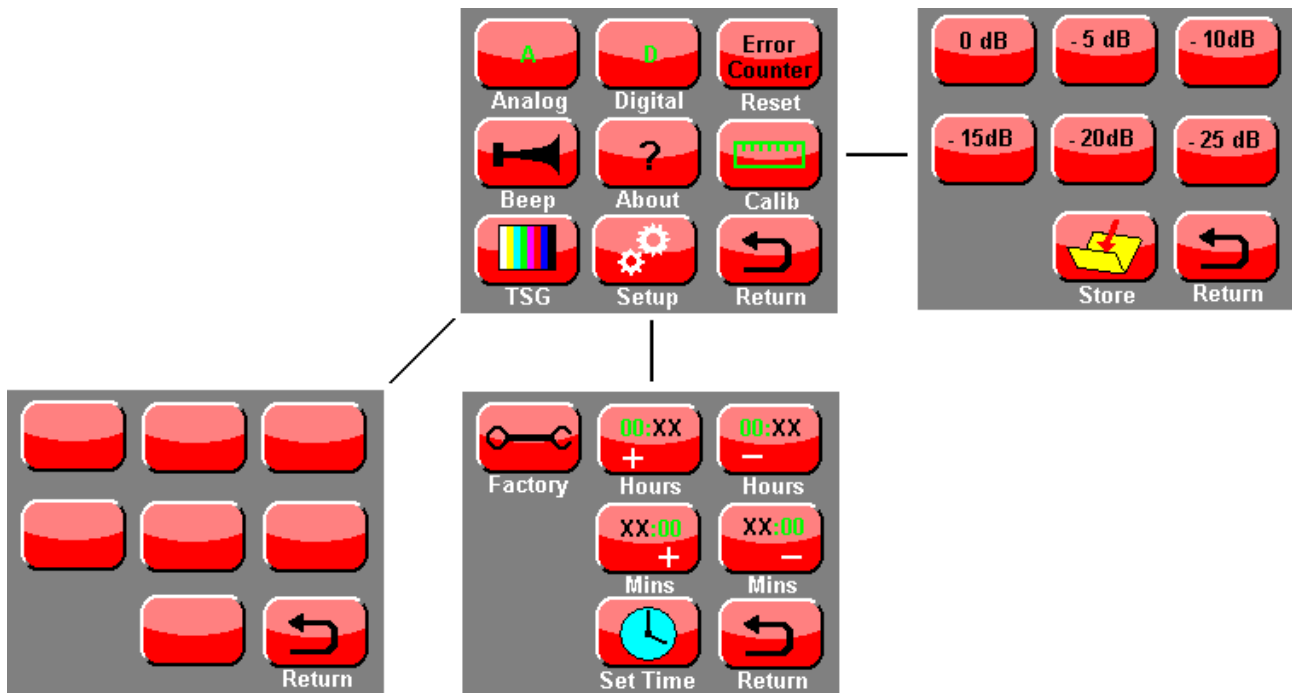
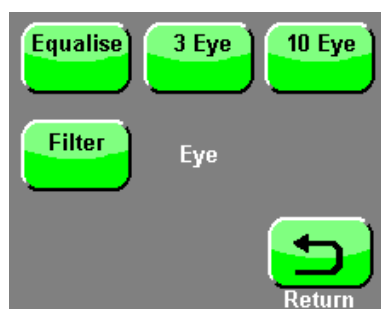

Fig 10

- Analog** This displays an analogue representation of the input video, complete with Syncs or tri-syncs as appropriate.
- Digital** This displays a totally digital representation of the input video.
- Reset** Resets all the error counters.
- Beep** Enables an audible "beep" when any key is pressed.
- About** This displays the software revision state on the main output status bar.
- Calib** This calibrates the cable level display. Using a cable clone, switch in attenuation and click on the matching icon. Click on Store to store the settings.
- TSG** Controls the optional signal generator module.
- Setup** Factory resets the unit to a default factory setting.
Hours +/- and Mins +/- set the clock. Click on "Set Time" to store the setting.
- Return** Takes you back to the top menu.

OPERATING INSTRUCTIONS

DISPLAY MENU



EYE

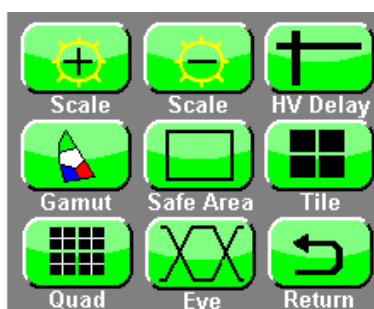

SAFE

Scale + Increases the brightness of the displayed graticules.

Scale - Decreases the brightness of the displayed graticules.

HV Delay Provides a picture horizontal and vertical shift, to show blanking areas.

Gamut This mode provides a waveform display with R, G and B traces superimposed, with a 1H timebase and low pass filtering. There are gamut lines at +3% and -1%.

Safe Area Selects safe areas on the picture output, as per the sub menu.

Tile Selects TILE mode, which shows waveform, vector, audio and picture displays in four quadrants. The individual top menu keys control each quadrant. Line select and gains don't operate in this mode.

Quad Selects Quad mode, which shows all four inputs together if all input modules are fitted. The individual top menu keys control what is displayed. Line select and gains don't operate in this mode.

Eye This will only operate if an Eye capable module is fitted in the selected input slot. Equalise enables or disables the input equaliser. 3 Eye selects a display of 3 eyes. 10 Eye selects a display of 10 eyes. Filter selects the frequency response of the clock recovery circuit. The loop-bandwidth is normally 1/1000 of the input clock frequency. This is doubled in HPF or halved in LPF, to help identify the frequency of any jitter present. The mode is displayed on the main output status bar.

Return Takes you back to the top menu.

OPTION MODULES

OPTION ONE

Module specification

SD/HD/3G digital input.

BNC connector. Input impedance 75 ohms. Max d.c. +/- 10V.

SMPTE 259M serial digital at 800mV p/p. Auto equalised up to 250 m of cable at 270Mb/s.

SMPTE 292M serial digital at 800mV p/p. Auto equalised up to 230 m of cable at 1.485Gb/s.

SMPTE 424M serial digital at 800mV p/p. Auto equalised up to 170 m of cable at 2.970Gb/s.

SD/HD digital output.

BNC connector. Output impedance 75 ohms. Equalised version of the serial digital input.

OPTION MODULES

OPTION TWO

OPTION MODULES

OPTION THREE

3G/HD/SD/CST EYE OPTION MODULE

This module provides all the features of the Option 1 module, with the addition of an EYE pattern display in SD, HD and 3G standards.

Cursor measurements

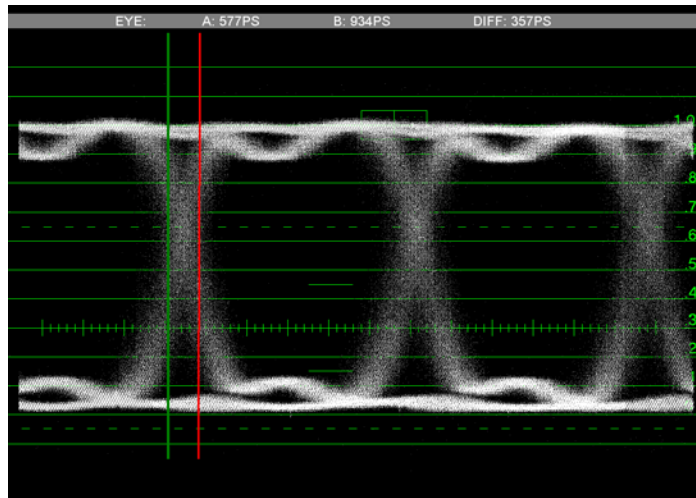

Fig 12

The front panel CURSOR A and CURSOR B controls allow precise timing measurements to be made on the EYE pattern.

Eye Measurement Basics

Eye diagrams are a very successful way of quickly and intuitively assessing the quality of a digital signal. A properly constructed eye should contain every possible bit sequence from simple 101's and 010's, through to isolated ones after long runs of consecutive zeros and other problem sequences that often show up weaknesses present in system design.

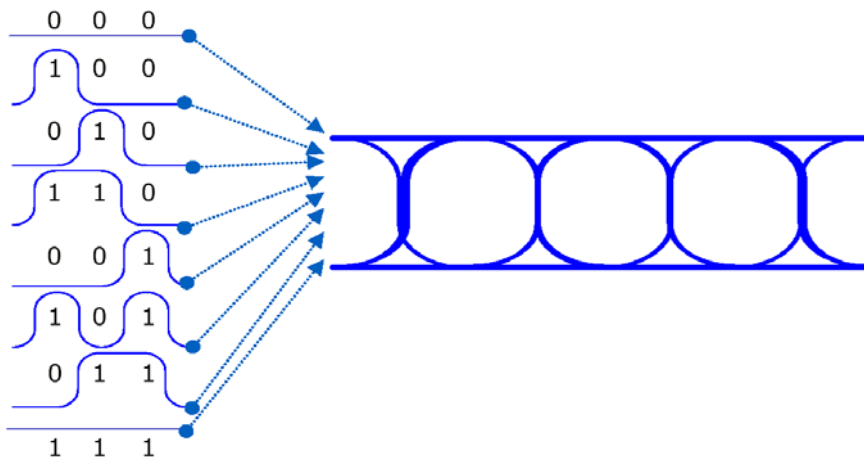

Fig 13. Overlaying of bit sequences to form an eye diagram.

Eye diagrams show parametric information about the signal – effects deriving from physics such as system bandwidth health etc. It will not show protocol or logical problems – if a logic 1 is healthy

on the eye, this does not reveal the fact that the system meant to send a zero. However, if the physics of the system mean that a logic one becomes so distorted while passing through the system that the receiver at the far end mistakes it for a zero, this should be shown in a good eye diagram. Common ways of characterizing an eye are to measure the rise times, fall times, jitter at the middle of the crossing point of the eye, the overshoot present and many other numerical descriptions of eye behaviour in order to compare devices being measured.

Jitter

As there is no separate clock available, the display has to trigger from recovered clock. Circuits used for recovering clock typically have a loop bandwidth, or filtering function, that removes from the clock signal some of the jitter that was present on the data signal. Depending upon the measurement being made, this can be helpful or hurtful, but needs to be understood. Narrow loop bandwidth clock recovery tends to give a rock solid clock trigger signal as the reference, and any jitter, or movement of edges with time, in the data eye diagram that is present will be displayed. This is a useful absolute measure but might not properly represent the jitter seen by a real system if the receiver uses clock recovery to track some of the jitter out.

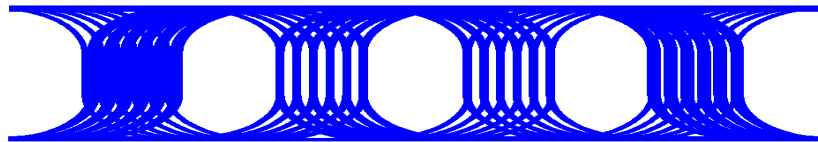

Fig 14. Clock recovered from the data signal using a narrow loop bandwidth clock recovery scheme.

Wide bandwidth clock recovery tends to let more of the jitter that was present on the data signal through on to the clock. This can mean that as the data jitters by moving edges in one direction, then the other; the recovered clock tracks it, and the resulting eye appears to have very little jitter present on it. This tracking function is the way many system receivers work to reduce the jitter passed on through the system.

Conditions can also conspire to create the opposite effect, where the delay between data signal and trigger signal is such that when the data edges are moving to their furthest extent in one direction, the recovered clock signal being triggered from it is moving to its furthest extent in the other, and the resulting eye shows as much as twice the jitter that was present on the data signal.

Equalisation

Long cable runs attenuate the higher frequency components in the serial data stream, effectively closing the eye. Although modern equalisers can compensate for this, there is still a limit, typically only 100 metres or so at 2.970Gb/s.

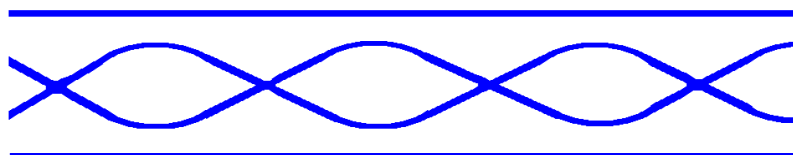

Fig 15. Closing eye due to high frequency attenuation.

Signal Specifications

SMPTE 259M

Amplitude 800mv +/- 10%

Rise and fall times between 0.4nS and 1.5nS. The difference should be less than 0.5nS.

Data rate is 270MHz

Cycle width is 1UI = 3.7nS

Jitter allowed is 0.2UI = 0.74nS

SMPTE 292M

Amplitude 800mv +/- 10%

Rise and fall times no greater than 0.27nS . The difference should be less than 0.1nS.

Data rate is 1485MHz

Cycle width is 1UI = 0.673nS

Jitter allowed is 1.0UI = 0.673nS

SMPTE 424M

Amplitude 800mv +/- 10%

Rise and fall times no greater than 0.27nS . The difference should be less than 0.1nS.

Data rate is 2970MHz

Cycle width is 1UI = 0.337nS

Jitter allowed is 2.0UI = 0.673nS

OPTION MODULES

GENERATOR

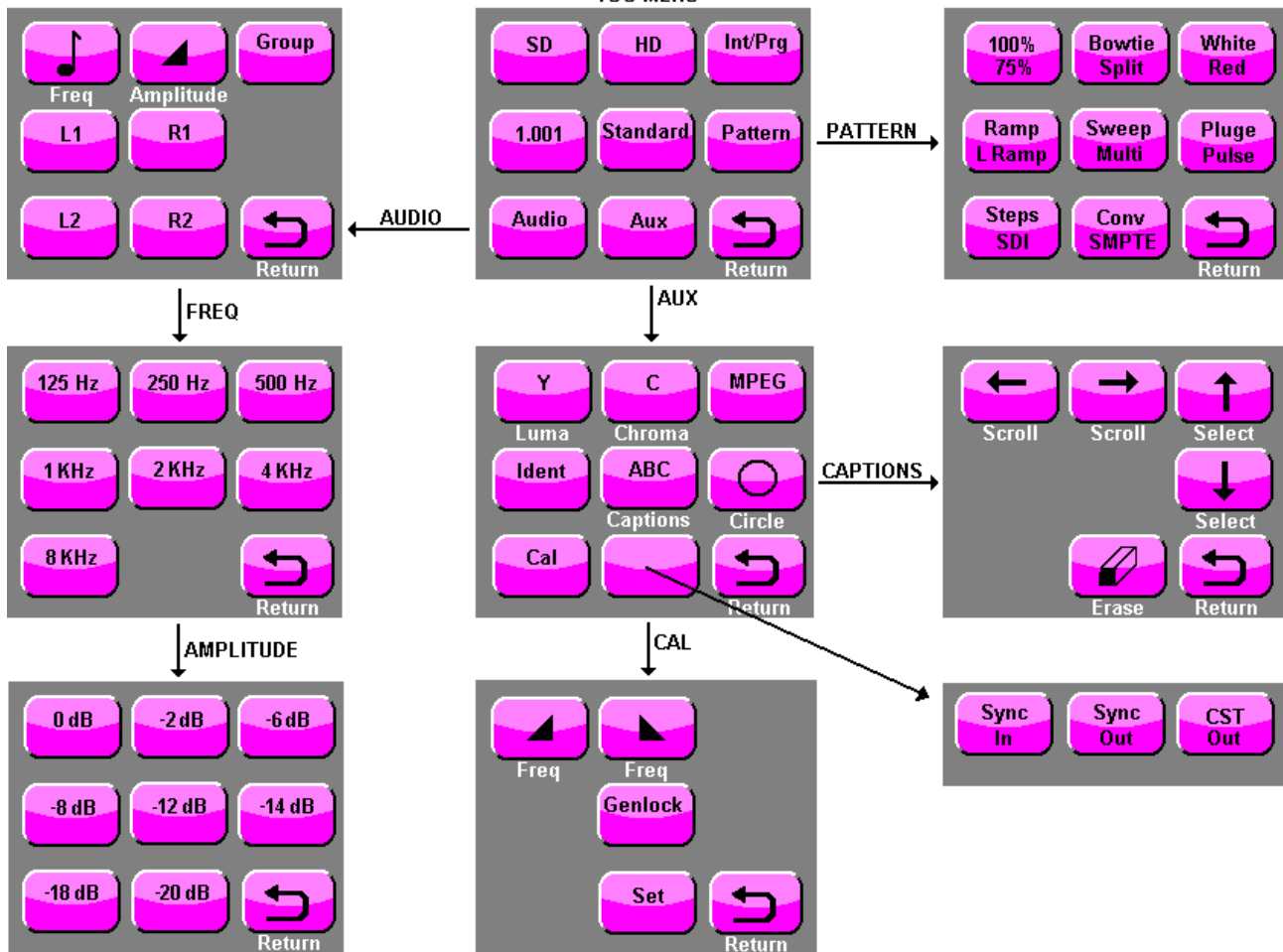

OUTPUT STANDARD

The selected standard is displayed on the output status text line.

VIDEO

The video Y and C components can be individually disabled from both outputs.

EMBEDDED AUDIO

Audio tone, with seven frequencies and eight amplitudes, can be embedded into any of the four groups, with individual channel control.

MPEG TEST

A moving black bar can be added to any pattern to check for stuck frames and MPEG coding errors.

IDENT TEXT

16 of 64 text characters can be superimposed on the selected pattern. To enter new characters or edit an existing ident caption, go to the GEN - AUX - EDT menu. The cursor can be moved to any 1 of 16 positions using the left/right arrows. The character over the cursor can be selected using the up/down arrows, Selecting from 0-9, A-Z, () ! & @ # . + - thus all character spaces can be set. The CLR key sets all characters to a white space.

CIRCLE

A white circle can be added to any pattern in 4:3 or 16:9 aspect ratios.

MASTER OSCILLATOR

The generator clock free running frequency can be calibrated using the menu, in 5ppm steps. Alternatively, it can Genlock to the external reference input.

COMPOSITE BNC

This has two functions, selectable in the AUX menu.

1. Black & Burst or Tri-Sync input.
2. Black & Burst or Tri-Sync output.

All settings are stored when the unit is switched off.

STANDARDS SUPPORTED

COMPOSITE

<u>STANDARD</u>	<u>FRAME RATE</u>	<u>SUBCARRIER</u>
NTSC	59.94	3.579545MHz
PAL	50.00	4.43361875MHz

SMPTE 259

<u>STANDARD</u>	<u>FRAME RATE</u>	<u>CLOCK</u>
711 x 487 (525)	59.94 2:1 I	13.5MHz
702 x 575 (625)	50 2:1 I	13.5MHz

SMPTE 274M

<u>STANDARD</u>	<u>FRAME RATE</u>	<u>CLOCK</u>
1920 x 1080	60 2:1 I	74.25MHz.
1920 x 1080	59.94 2:1 I	74.25MHz/1001
1920 x 1080	50 2:1 I	74.25MHz
1920 x 1080	30 1:1 P	74.25MHz
1920 x 1080	29.97 1:1 P	74.25MHz/1001
1920 x 1080	25 1:1 P	74.25MHz
1920 x 1080	24 1:1 P	74.25MHz
1920 x 1080	23.98 1:1 P	74.25MHz/1001
1920 x 1080	30 S.F.	74.25MHz
1920 x 1080	29.97 S.F.	74.25MHz/1001
1920 x 1080	25 S.F.	74.25MHz
1920 x 1080	24 S.F.	74.25MHz
1920 x 1080	23.98 S.F.	74.25MHz/1001

SMPTE 296M

<u>STANDARD</u>	<u>FRAME RATE</u>	<u>CLOCK</u>
1280 x 720	60 1:1 P	74.25MHz
1280 x 720	59.94 1:1 P	74.25MHz/1001
1280 x 720	50 1:1 P	74.25MHz

SMPTE 424M

<u>STANDARD</u>	<u>FRAME RATE</u>	<u>CLOCK</u>
1920 x 1080	60 1:1 P	148.5MHz.
1920 x 1080	59.94 1:1 P	148.5MHz/1001
1920 x 1080	50 1:1 P	148.5MHz

PATTERNS

100% BARS

100% full colour bars.

Digital levels are Yblack =64, Ywhite = 940, Cr and Cb are 512 +/- 448 max.

75% BARS

White as 100% bars. Colours reduced to 75% level.

SPLIT

Top half of screen is 100% colour bars, bottom half is full red.

BOWTIE

Y channel is 500KHz. Cr,Cb channels are 502KHz phase adjusted so equal to Y in mid line.

Suitable monitoring equipment, e.g. the Hamlet LCDScope 292WVA, produce (Y-Cr) and (Y-Cb) displays to accurately check system gains and timings, with the traditional bowtie displays.

Y Waveform is 438 bits (350mV) p/p centred on 502 bits (350mV).

C Waveform is 448 bits (350mV) p/p centred on 512 bits (350mV).

Timing markers at +/-5nSec and at every 20nSec.

SWEEP

SD sweeps from 500KHz to 5MHz over the line period, with markers at 1,2,3,4,5 MHz.

HD sweeps from 1MHz to 30MHz over the line period, with markers at 5,10,15,20,25 MHz.

Waveform is 600bits (480mV) p/p centred on 502 bits (350mV).

PLUGE

Grey scale block for colour monitor gain tracking adjustment and grey/superblack stripes for brightness setting.

Block is 940 bits (700mV), 502 bits (350mV), 239 bits (140mV).

Stripes are at 64 +/- 18bits (+/- 14mV).

MULTI

525 SD is a white bar at 765 bits (560mV) followed by six frequency bursts at 500KHz, 1.25MHz, 2MHz, 3MHz, 3.58MHz, 4.2MHz at 526 bits (370mV) p/p centred on 502 bits (350mV).

625 SD is a white bar at 765 bits (560mV) followed by six frequency bursts at 500KHz, 1MHz, 2MHz, 3MHz, 4MHz, 5MHz at 526 bits (370mV) p/p centred on 502 bits (350mV).

HD is a white bar at 765 bits (560mV) followed by five frequency bursts at 5MHz, 10MHz, 15MHz, 20MHz and 25MHz at 526 bits (370mV) p/p centred on 502 bits (350mV).

PULSE+BR

2T luma pulse at 940 bits (700mV), 10T chroma pulse at 502 bits (350mV), bar at 940 bits (700mV).

MOD STPS

5-step ascending staircase, equal steps of 175 bits (140mV) each.

Added chroma of Cr at 638 bits and Cb at 652 bits.

WHITE

Plain full white screen.

Y waveform 940 bits (700mV), Cr is 512 bits, Cb is 512 bits.

PATTERNS

RED

Plain full red screen.

Y waveform is 250 bits (149mV), Cr is 960 bits, Cb is 409 bits.

CONVERGE

Crosshatch pattern for colour monitor convergence adjustment.

DIG CHK

Top half of the screen is the equaliser test and contains several examples of 19 "0"s followed by 2 "1"s per frame.

Bottom half of the screen is the phase locked loop test and contains several examples of 20 "0"s followed by one "1" per frame.

RAMP

Y waveform is an ascending ramp, running from 64 bits (0mV) to 940 bits (700mV).

Cr and Cb waveforms are ascending ramps, running from 64 (-350mV) to 960 (+350mV)

LIM RAMP

Y waveform is an ascending ramp, running from 1 bit (50 mV below black) to 1022 bits (66 mV above peak white).

TECHNICAL SPECIFICATION

OUTPUTS

Composite	BNC connector. Output impedance 75 ohms. PAL or NTSC.
SD Serial digital	BNC connector. Output impedance 75 ohms. SMPTE 259M, ITU-R BT.601/656 serial component. 800mV pp
HD Serial digital	BNC connector, output impedance 75 ohms. SMPTE 292, serial component. 800mV pp
3G Serial digital	BNC connector, output impedance 75 ohms. SMPTE 424M, serial component. 800mV pp

Full 10 bit pattern generation.

OPTIONS

AUDIO OPTION

REMOTE CONTROL

ADDITIONAL FUNCTIONS

To start the unit in a known state

Powering on the unit normally will recall the settings previously used, but if previous settings were non-standard, factory set mode can be established to allow faster use.

Menu selection is DATA - SETUP - FACTORY.

Factory mode can also be loaded at boot up. With the unit turned off, press the right hand LCD touch panel and switch on. Continue holding for at least 5 seconds.

To store and recall user settings

8 sets of front panel setting can be stored for later recall.

To Store Settings: Press the front panel STR button, then a menu 1 - 8 key.

To Recall the settings: Press the front panel RCL button, then a menu 1 - 8 key.

Power Source

The Hamlet DS900 can be powered from the supplied adaptor, providing 12V @ 3 amps regulated, or from the optional external battery pack.

TECHNICAL SPECIFICATION

OPTION 1/3

INPUT

BNC connector. Input impedance 75 ohms. Max d.c. +/- 10V.

Serial digital at 800mV p/p.

Auto equalised up to 400 metres of cable at 270mb/s.

Auto equalised up to 200 metres of cable at 1.485Gb/s.

Auto equalised up to 140 metres of cable at 2.97Gb/s.

SDI output.

BNC connector. Output impedance 75 ohms. Equalised version of the serial digital input.

Ext-ref input.

BNC connector. Input impedance 75 ohms. Max dc +/- 3 volts.

Video 0.5 to 2.0V p/p or Black & Burst or Tri-Sync.

OUTPUT

XVGA

DVI-I socket with analogue and digital signals.

AUDIO MONITORING OUTPUT

3.5mm stereo jack socket.

REMOTE CONTROL

ETHERNET or USB

TECHNICAL SPECIFICATION

POWER

10 to 13V d.c. to 4 pin XLR socket. 3A max.

ENVIRONMENT

Indoor use, 5 to 45 deg.C. ambient to 2,000m.

Max humidity 80% to 31 deg.C decreasing to 50% at 40 deg.C.

Overvoltage category 2. Pollution degree 1.

Weight 3Kg.

RESOLUTION

1024 pixels wide x 768 pixels high.

WAVEFORM MONITOR

Response

Flat is +/- 1% 50Hz to 5.5MHz
30.0MHz in HD modes, 70.0MHz in 3G modes.

Low Pass is -3db @ 1.5MHz, -60db @ 6.75MHz.

Timebase

H, 2H and Hmag (x5).
V, 2V and Vmag.
Line select is any line from the frame.
Parade is YCrCb left to right.

VECTOR MONITOR

Video

Traditional component display.
Accuracy 0.2%. B/width 3.4MHz (15MHz in HD modes).

Audio

Stereo phase display of CH1 or CH2 audio pair.
Phase accuracy 2 deg.

AUDIO MONITOR

Accuracy

Better than 0.1db over full scale range.

Characteristics

BBC, EBU, VU, NORDIC, DIGITAL, DIN and
EXPANDED DIN.

TROUBLE SHOOTING

Unit appears dead:

Check that the 12V supply adaptor is plugged into the unit and that this is plugged into an operational mains supply, or the external battery pack is fresh. Ensure the front panel LCD screens are illuminated.

No video displayed:

If there is no video signal connected to the selected input, the centre screen and main output will display the message “No Signal”. Check that channel input button is green for the selected channel.

Unusual display:

The unit may be set to a non-standard mode. Reset the unit as follows.

Menu selection is DATA - SETUP - FACTORY.

Displays not locked:

May be in external reference mode. Press the menu EXT REF menu key to cancel. This may need pressing twice to step through the HFT mode.

SERIAL DIGITAL BASICS

625 and 525 digital component video is produced by applying a 4:2:2 sampling structure to the analog signal. This process is defined by a sub-set of international standards ITU-R BT.601 and BT.656. (these were formerly known as CCIR-601 and CCIR-656. The label 'CCIR601' is commonly applied to digital video coded in this manner.)

The luminance (Y) component is sampled at 13.5 MHz, and the colour difference components (U and V) are both sampled at 6.75 MHz. With 10 bit quantisation, this results in a data stream of 10 bit words at a clock frequency of 27 MHz. If the signal source uses 8 bit quantisation, 10 bit data is used with the two least significant bits of each sample code set to binary zero. This is to maintain the same data rate.

The quantizing levels employed in the analog to digital conversion are set to give 66.4mV headroom above peak white and 51.1mV below black. Coded U and V signals have 50mV above and below their normal maximum and minimum excursions.

The synchronisation pulses are discarded in the coding process, and are replaced by Timing Reference Signals (TRS) which are inserted into the data stream to serve the same purpose. Two TRS's are used to synchronise the data stream, EAV (End of Active Video) and SAV (Start of Active Video). These are placed at the beginning and end of the horizontal video blanking period. see fig 15.

Each TRS consists of 4 words:

- 1) 3ff hex ie all '1's
- 2) 000 hex ie all '0's
- 3) 000 hex ie all '0's
- 4) XYZ, which determines the type of TRS pulse:

XYZ:

- Bit 9: always '1'
- Bit 8: 0 = frame 1 1 = frame 2
- Bit 7: 0 = normal 1 = field blanking
- Bit 6: 0 = SAV 1 = EAV
- Bit 5: Bits used for Hamming correction.
- Bit 4: Bits used for Hamming correction.
- Bit 3: Bits used for Hamming correction.
- Bit 2: Bits used for Hamming correction.
- Bit 1: Always '0'
- Bit 0: Always '0'

SERIAL DIGITAL BASICS

The period between EAV and SAV is not used by normal video and is available for other purposes eg: error checking, timecodes or embedded audio.

Illegal Values: The values 0 and 3FF hex are used solely by TRS pulses (EAV and SAV) they must not appear anywhere in the active video area.

Out of Gamut: Values apart from the illegal values which should not be used.

Luminance is defined as being between peak white, 700mV 3AC, hex and black, 0mV 040 hex.

Chroma is defined as being between max positive, 350mV 3C0, hex and max negative, -350mV 040 hex.

The values above and below these are termed out of gamut.

The data is serialised using an NRZ (None Return to Zero) code to produce a 270 Mb/s signal. This coding method removes any low frequency component and is insensitive to polarity. The data has to be scrambled first to avoid the possible transmission of all '0's.

This data is output at 800mV p-p to normal 75 ohm video coaxial cable.

Due to the high frequencies, the cable losses are quite high, typically 10dB per 100 metres at 270 MHz. To allow acceptable cable lengths, automatic cable equalisers are used at the receiver which usually allow up to 300 metres of cable to be used. It is important that standard cable is used, otherwise the equaliser will not compensate correctly.

Suitable cable is: PSF 2/3 BELDEN 8281 F&G 1.0/6.6

DIGITAL ERROR DETECTION OVERVIEW

In order to check if the digital video signal has been received correctly a Cyclic Redundancy Check (CRC) can be made on each frame in the generating equipment, this four digit number is then placed in a 'packet' and put in the EAV-SAV space of one line of each field.

At the receiving equipment the incoming video field also has a Cyclic Redundancy Check number calculated, this value is then compared with the 4 digit number sent in the packet. If the two numbers are not identical an error has occurred between transmission and reception of the signal.

SERIAL DIGITAL BASICS

This type of error detection is known as Error Detection and Handling or EDH and is defined by SMPTE RP165. In practice two check sums are sent per frame, one for the active video period and one for the full frame. A typical packet consists of:

The Header: (000, 3FF, 3FF) This always precedes an EDH packet.

Data ID: (1F4)

Block Number: (200)

Data Count: This contains the number of words that follow.

Active picture crc: 3 words

Full-field crc: 3 words

Error flags: 3 words

Reserved: 7 words

Check Sum: This is used to test for transmission errors.

EMBEDDED AUDIO OVERVIEW

The period between the EAV and SAV markers can be used to send embedded digital audio signals. This is known as SMPTE 272M. Up to 16 separate audio signals may be sent in a single video channel. These are organised as four GROUPS of four signals, the four signals are often two stereo pairs. Typically only one group will be used, giving two stereo pairs of audio. The audio data is digitised in the sending equipment to 20 bits of resolution, usually at a 48 KHz sample rate. Often only 16 bits are used in practice. The digitised data is arranged in packets which are placed in the EAV-SAV space.

A typical packet consists of:

The Header: (000, 3FF, 3FF) This always precedes an audio packet.

Data ID: This contains the Audio Group number.

Block Number: AES blocks have 192 'frames' of audio data

Data Count: This contains the number of words that follow.

Audio Sample:

Audio Sample:

Audio Sample:

Audio Sample:

Check Sum: This is used to test for transmission errors.

Each audio sample consists of a sample of all four audio signals,

eg: Channel 1 left, Channel 1 right, Channel 2 left, Channel 2 right.

Each signal requires 3 words to hold all 20 bits data, thus each audio sample has 12 words in it.

Typically 3 or 4 audio samples are sent in each EAV-SAV period.

As with the video signal, words which consist of all '1's or all '0's are not allowed.

SERIAL DIGITAL BASICS

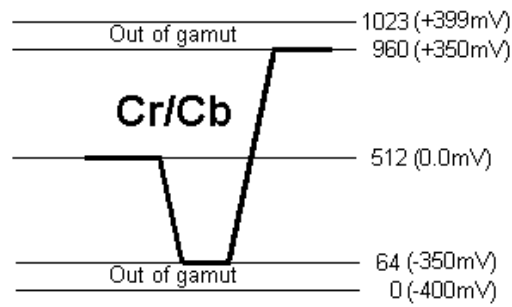
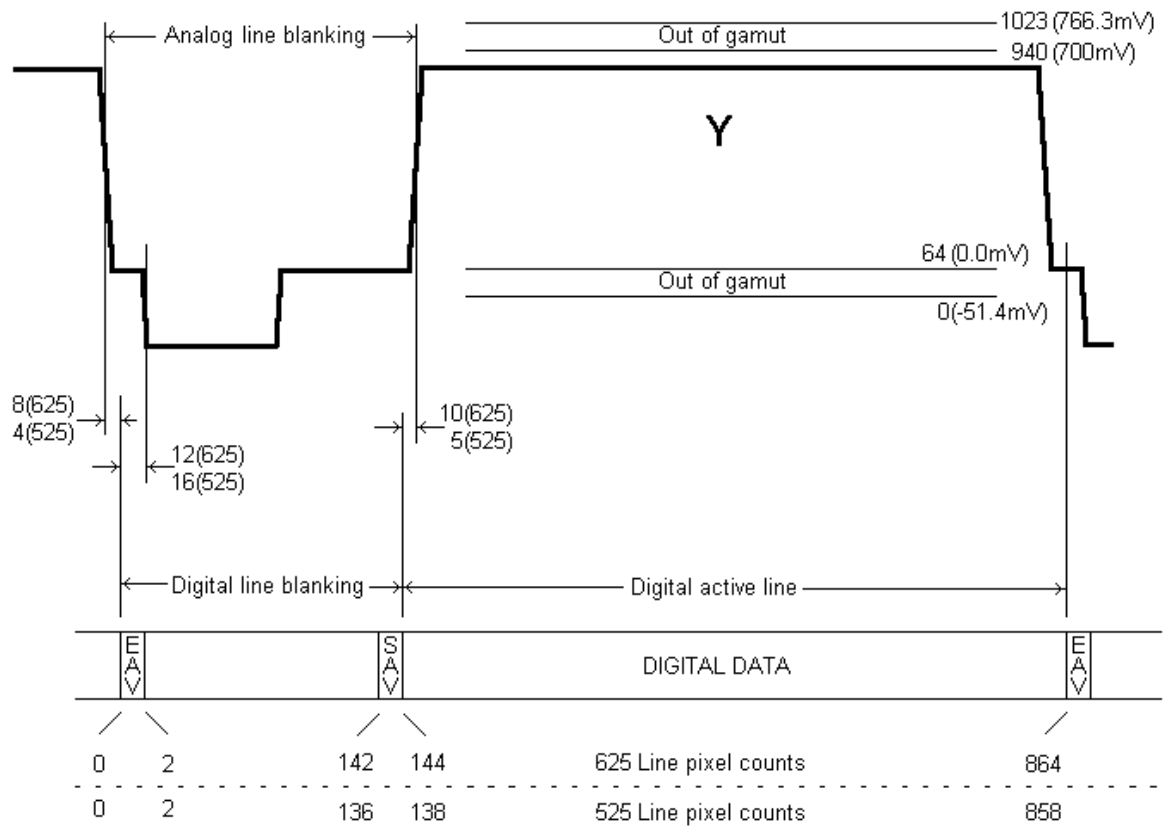
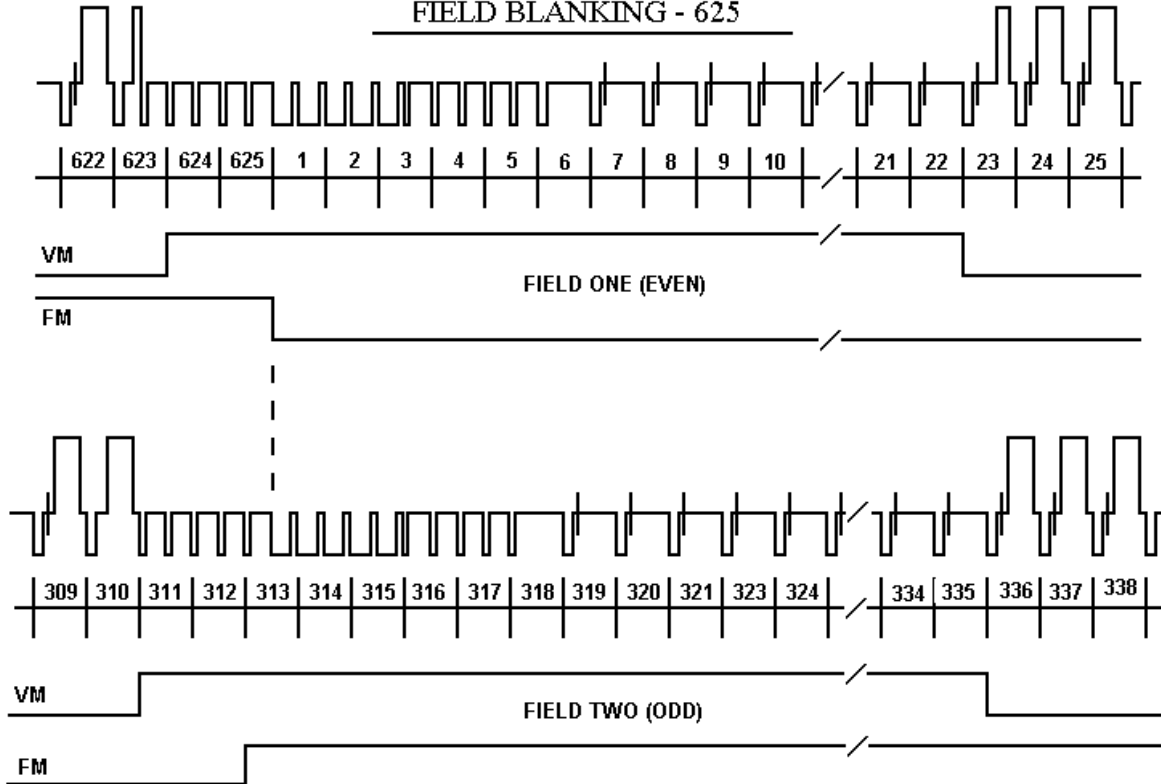

Fig 16

SERIAL DIGITAL BASICS

FIELD BLANKING - 625



FIELD BLANKING - 525

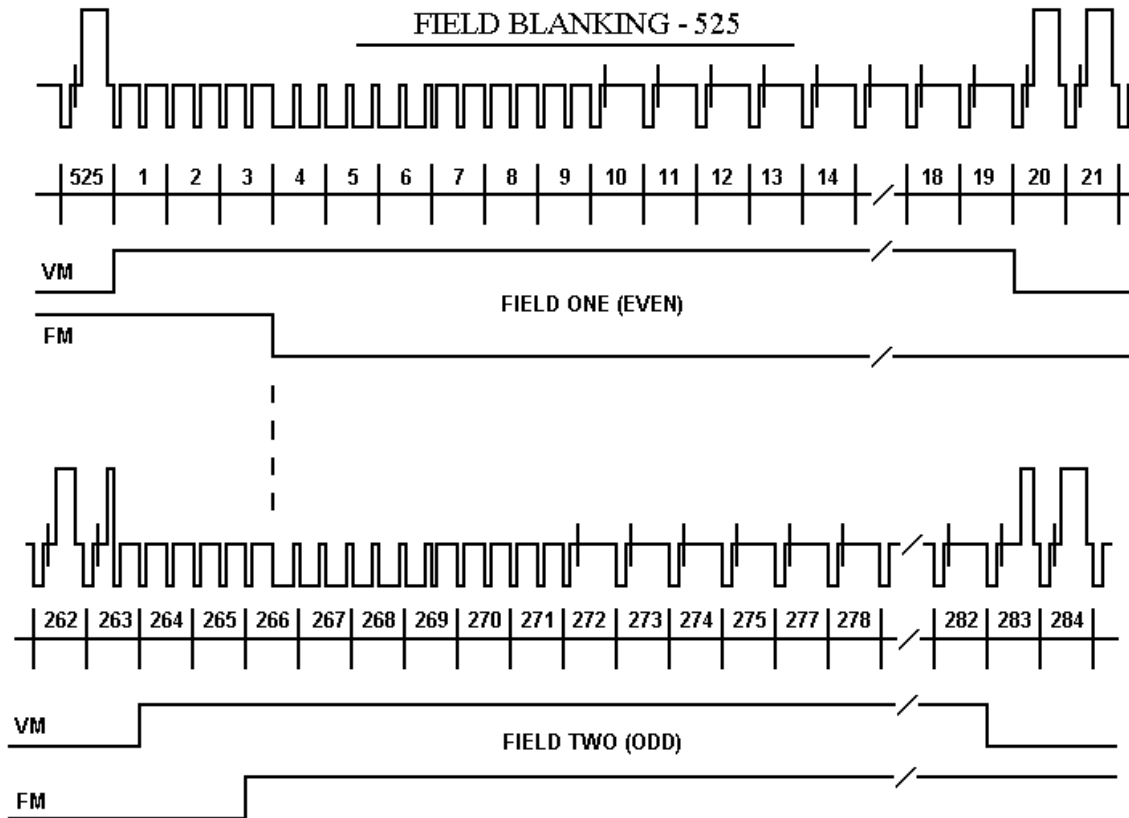

Fig 17/18

HD SERIAL DIGITAL BASICS

BIT SERIAL DIGITAL INTERFACE DEFINED BY SMPTE 292M.

HDTV digital component video is produced by applying a 4:2:2 sampling structure to the analog signal. The luminance component (Y) is sampled at 74.25 MHz, the colour difference components U & V) are both sampled at 37.125 MHz.

The Y stream is quantised to 10 bits resolution and Timing Reference Signals (TRS) are added at the beginning and end of the horizontal video blanking period.

The U & V streams are also quantised to 10 bits and then interleaved to give a C stream at 74.25 MHz. TRS are added at the beginning and end of the horizontal video blanking period.

The 74.25MHz Y and C streams are then interleaved to produce a single stream at 148.5MHz. This data is then scrambled and serialised using a Non Return to Zero (NRZ) code to produce a 1.485 GHz signal.

The TRS at the end of the horizontal blanking period is called Start of Active Video (SAV) it consists of 4 words:

- 1) 3FF hex ie all '1's
- 2) 000 hex ie all '0's
- 3) 000 hex ie all '0's
- 4) XYZ, which determines the type of TRS pulse, consisting of:

Bit 9: Always '1'

Bit 8: 0=frame 1, 1=frame 2

Bit 7: 0=normal 1=field blanking

Bit 6: 0=SAV 1=EAV

Bit 5: Bits used for Hamming correction.

Bit 4: Bits used for Hamming correction.

Bit 3: Bits used for Hamming correction.

Bit 2: Bits used for Hamming correction.

Bit 1: Always 0

Bit 0: Always 0

The TRS at the beginning of the horizontal blanking period is called End of Active Video (EAV) it consists of 8 words: The first 4 are the same as for SAV, followed by 2 words containing the current line number and 2 words containing a Cyclic Redundancy Check (CRC) for all the preceding words in the line. The period between EAV and SAV is not used by normal video and may be used for embedded audio or timecode data.

ILLEGAL VALUES

The values 000 and 3FF hex are used solely by TRS pulses (EAV & SAV) they must not appear anywhere in the active video area.

SAMPLE STRUCTURE

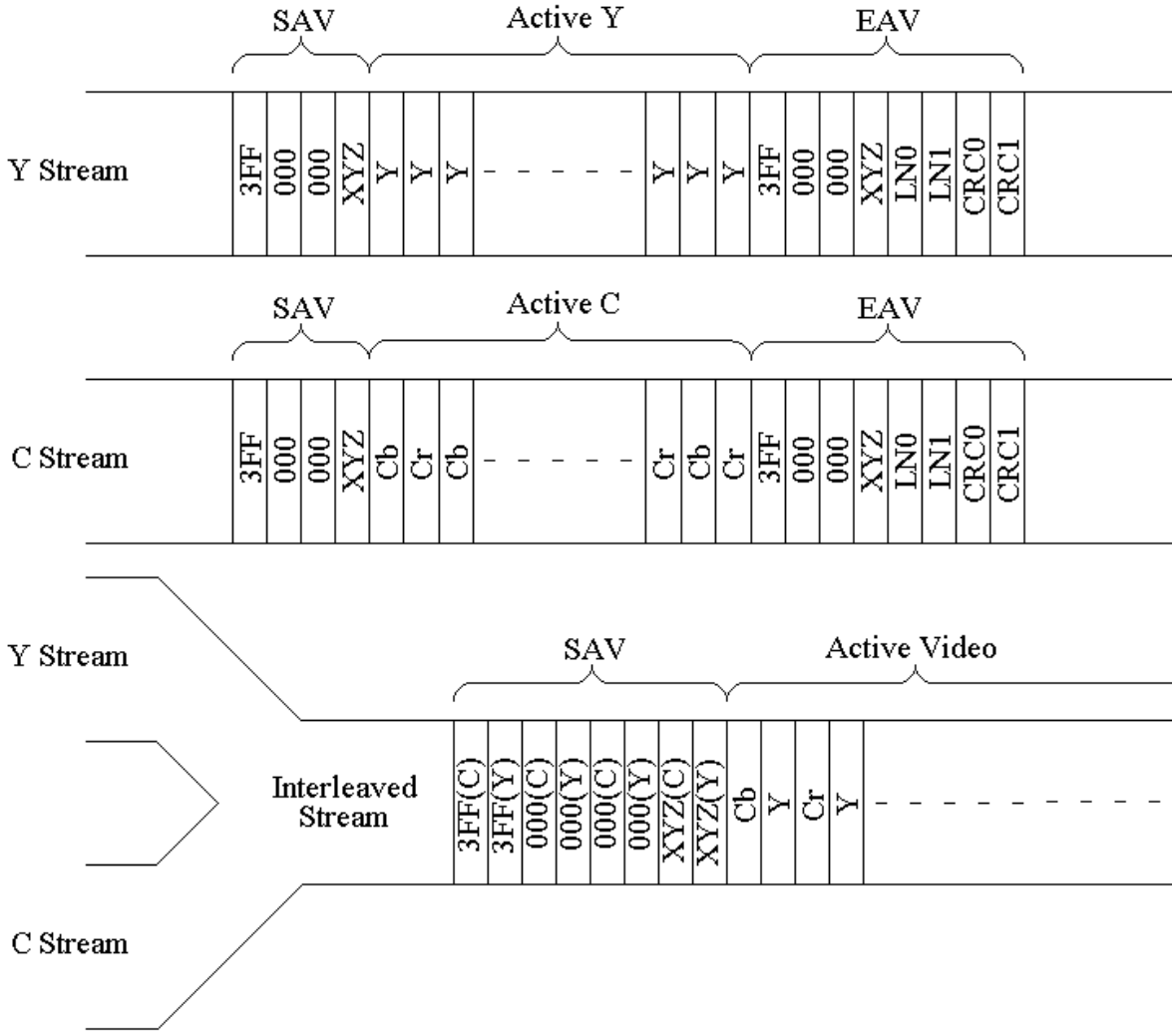

Fig 19

PARALLEL DIGITAL INTERFACES

Several parallel video Standards can be used with the above serial interface. These are defined in SMPTE 274M for 1920 x 1080 scanning and SMPTE 296M for 1280 x 720 scanning.

SMPTE 274M

Several sub-standards for this are defined:

1920 x 1080/60/2:1

1920 samples/active line 1080 active line/frame 30PsF segmented format.
74.25 MHz Sample frequency 2200 total samples/line 1125 total lines/frame

1920 x 1080/59.94/2:1

1920 samples/active line 1080 active line/frame 29.97PsF segmented format.
74.176 MHz Sample frequency 2200 total samples/line 1125 total lines/frame
This standard gives an exact frame rate compatibility with NTSC.

1920 x 1080/50/2:1

1920 samples/active line 1080 active line/frame 25PsF segmented format.
74.25 MHz Sample frequency 2640 total samples/line 1125 total lines/frame

1920 x 1080/30/1:1

1920 samples/active line 1080 active line/frame 30 Hz Progressive scan.
74.25 MHz Sample frequency 2200 total samples/line 1125 total lines/frame

1920 x 1080/29.97/1:1

1920 samples/active line 1080 active line/frame 29.97 Hz Progressive scan.
74.176 MHz Sample frequency 2200 total samples/line 1125 total lines/frame
This standard gives an exact frame rate compatibility with NTSC.

1920 x 1080/25/1:1

1920 samples/active line 1080 active line/frame 25 Hz Progressive scan.
74.25 MHz Sample frequency 2640 total samples/line 1125 total lines/frame

1920 x 1080/24/1:1

1920 samples/active line 1080 active line/frame 24 Hz Progressive scan.
74.25 MHz Sample frequency 2750 total samples/line 1125 total lines/frame

1920 x 1080/24sf

1920 samples/active line 1080 activelines/frame 24 Hz segmented frame
74.25 MHz sample frequency 2750 total samples/line 1125 total lines/frame

1920 x 1080/23.98/1:1

1920 samples/active line 1080 active line/frame 23.98 Hz Progressive scan.
74.176 MHz Sample frequency 2750 total samples/line 1125 total lines/frame

HD SERIAL DIGITAL BASICS

SMPTE 296M

Several substandards for this are defined:

1280 x 720/60/1:1

1280 samples/active line 720 active line/frame 60 Hz Progressive scan.
74.25 MHz Sample frequency 1650 total samples/line 750 total lines/frame

1280 x 720/59.94/1:1

1280 samples/active line 720 active line/frame 59.94 Hz Progressive scan.
74.176 MHz Sample frequency 1650 total samples/line 750 total lines/frame

1280 x 720/50/1:1

1280 samples/active line 720 active line/frame 50 Hz Progressive scan.
74.25 MHz Sample frequency 1980 total samples/line 750 total lines/frame

EMBEDDED AUDIO

The period between EAV and SAV can be used to send embedded digital audio signals. This is defined in SMPTE 299M. Up to 16 separate audio signals may be sent in a single video channel. These are organised as four GROUPS of four signals, the four signals are often two stereo pairs. Typically only one group will be used, giving two stereo pairs of audio. The audio data is quantised in the sending equipment to 24 bits of resolution, usually at 48 KHz sample rate in AES/EBU format. The digitised data is arranged in packets which are placed in the EAV-SAV space.

A packet consists of:

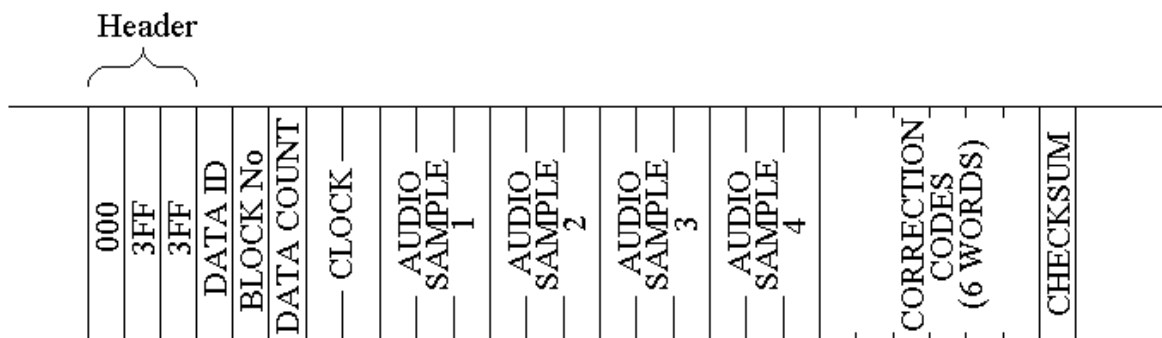

Fig 20

HD SERIAL DIGITAL BASICS

The Header: (000, 3FF, 3FF)

Data ID: This contains the Audio group number.

Data block number: AES frames have 192 samples of audio data

Data Count: This contains the number of words that follow, always 218 hex

Clock: 2 words containing the number of video clocks that have elapsed between the first word of EAV and the time the audio sample was made, it is used by the receiving equipment to reconstruct the audio signal with the correct phase delay.

Audio Sample 1: Consists of four words

Audio Sample 2: Consists of four words

Audio Sample 3: Consists of four words

Audio Sample 4: Consists of four words

Error Correction Codes

Consist of six words used by the receiving equipment to detect or correct errors in the 24 words from the header to the last word of audio sample 4 inclusive.

Check Sum This is the sum of all previous words in the packet except the header words.

Each audio packet contains a sample of all four audio signals

eg: Channel 1 left, Channel 1 right, Channel 2 left and Channel 2 right.

Each audio signal requires 3 words to hold all 24 bits, thus each audio packet has 12 words of audio data.

Typically one or two packets are sent in each EAV-SAV period.

These audio data packets are placed in the Chroma data stream only.

Audio Control Packets.

The audio control packet structure is similar to the audio data packet.

Data in the packet includes the audio sample rate eg 48 KHz,

the number of active channels out of the possible 4,

the delay information between Channel 1 audio and Channel 2

and delay information between Channel 3 audio and Channel 4.

Audio control packets are placed in the Luminance Stream, this is sent once per frame in the second line after the switching point.

As with the video signal, words consisting of all '1's or all '0's are not allowed.

COMPOSITE BASICS

COMPONENT COLOUR

The colour picture can be distributed in two forms, whether in 625 or 525 line standards:

RGB

This is the basic signal produced by a camera etc and fed to a colour monitor. It consists of three primary signals, **R**ed, **G**reen and **B**lue. By convention, black level is at 0mV and peak brightness is at + 700mV.

YCrCb

As the human eye can see less resolution with colours, the video can be modified to take advantage of this to reduce the amount of information needed. The picture is separated into monochrome and colour components. The monochrome Y signal is formed from:

$Y = (0.3 \times \text{Red}) + (0.59 \times \text{Green}) + (0.11 \times \text{Blue})$ approximately.

This signal has black level at 0mV and maximum white level at + 700mV.

The colour components are two colour difference signals:

$Cr = (R - Y)$ and $Cb = (B - Y)$

These are weighted to give maximum values of +/- 350mV and are bandwidth restricted to half that of the Y component.

PAL

Fig 18 shows an encoded 100% colour bar signal. The two colour components of Cr and Cb are used to amplitude modulate a 4.43361875Mhz carrier signal. The two carriers are arranged to be 90 degrees apart before they are combined with the Y luminance signal, so that they can be decoded separately. The PAL system is designed to minimise hue errors by phase reversing the Cr axis on alternate lines (**P**hase **A**lternate **L**ine). This reversal is copied by the decoder, so that the hue error will now alternate in phase. By combining the chrominance from two adjacent lines, the error is thus cancelled out.

NTSC

Fig 19 shows an encoded SMPTE (75%) colour bar signal. The two colour components of Cr and Cb are used to amplitude modulate a 3.579545Mhz carrier signal, but they are first modified into I and Q signals to reduce the overall maximum chrominance level when combined.

PAL BASICS

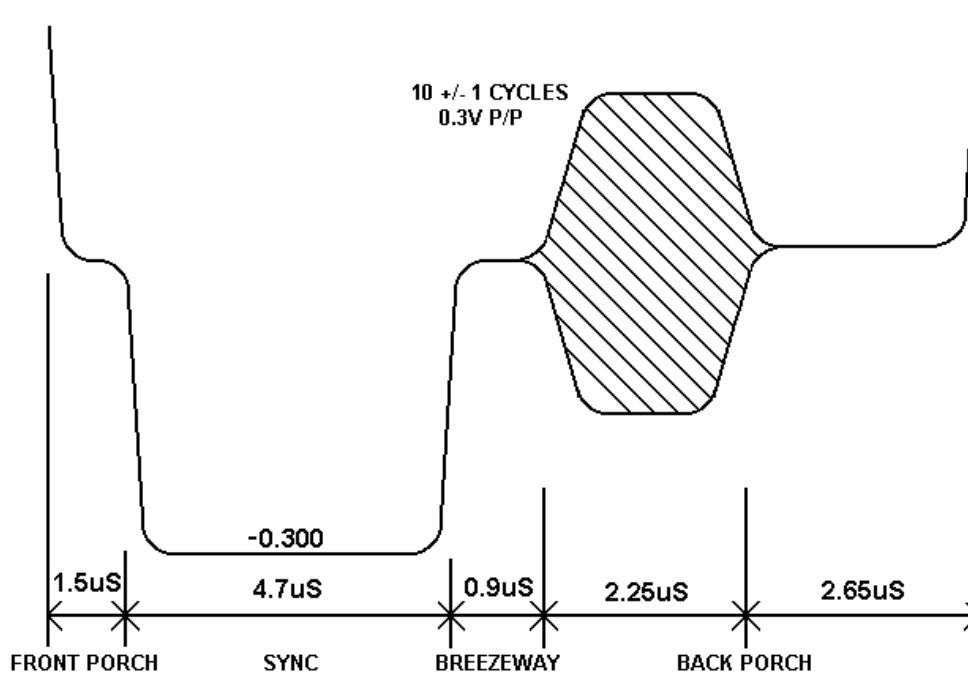
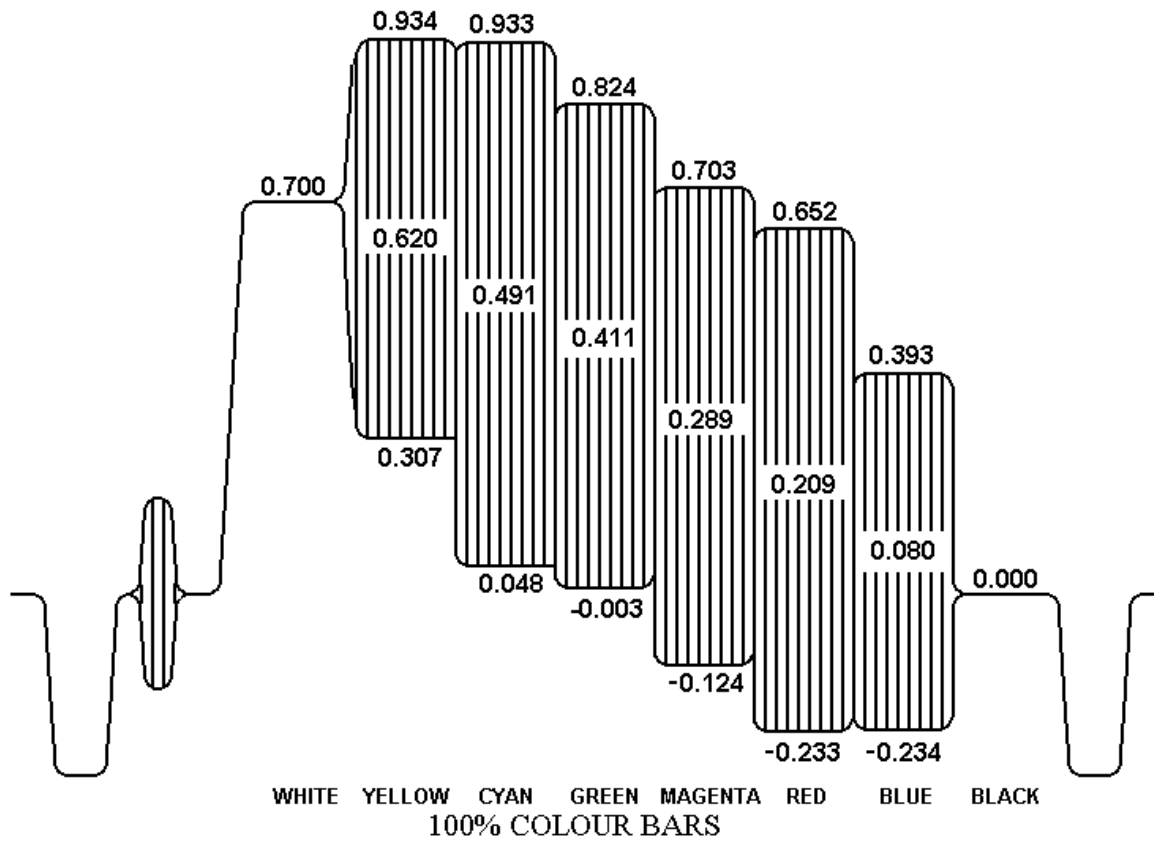

Fig 21

NTSC BASICS

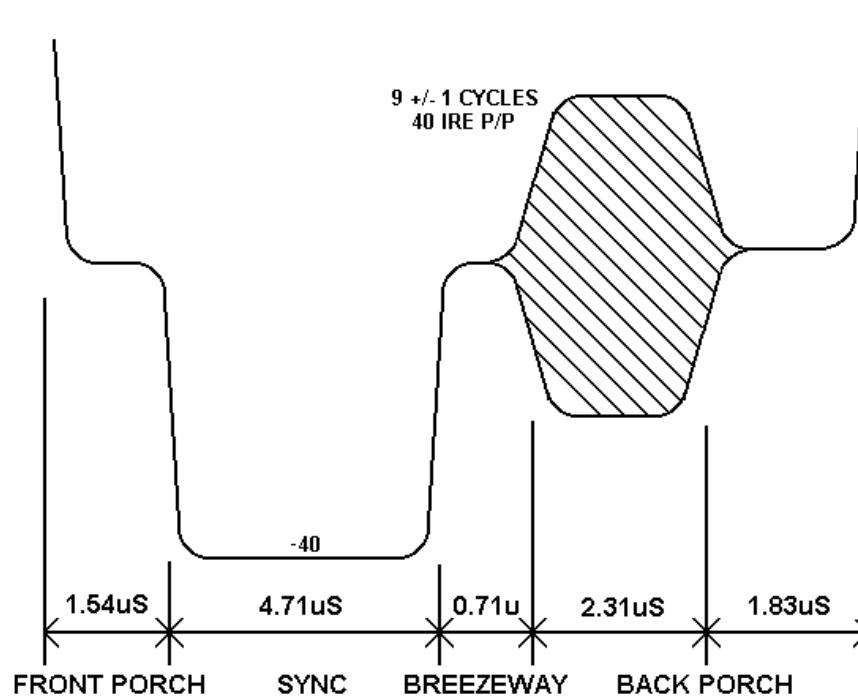
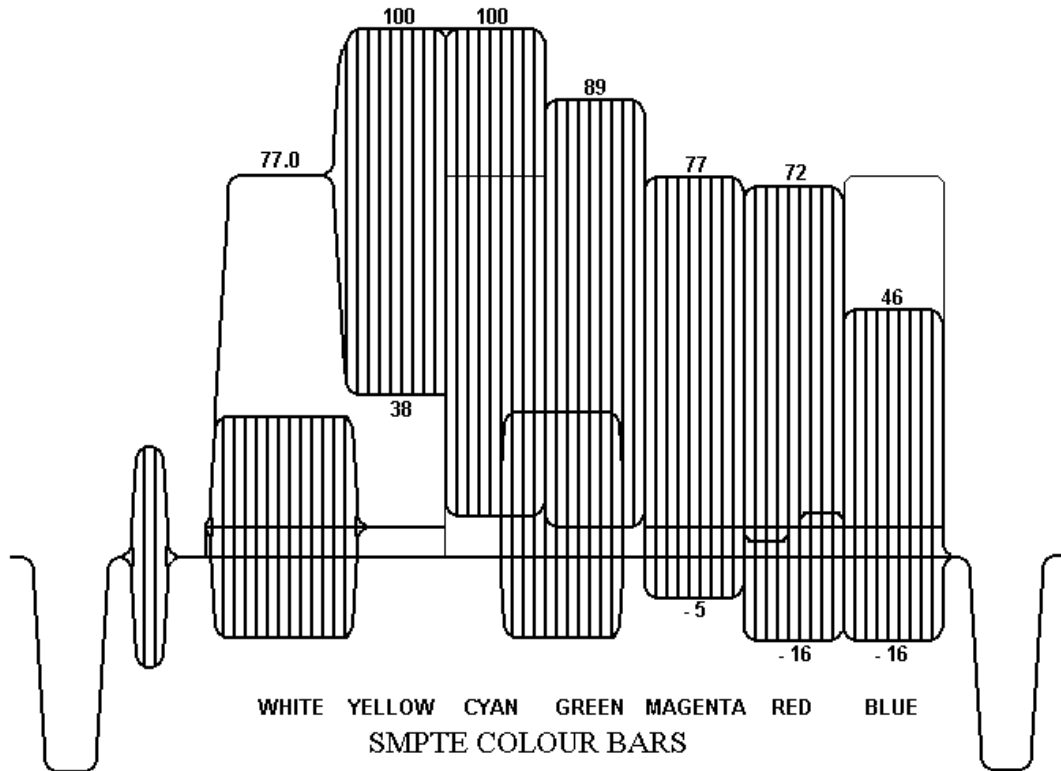

Fig 22

USEFUL WEBSITES

HAMLET	www.hamlet.co.uk	
HAMLET (USA)	www.hamlet.us.com	
SMPTE	www.smpte.org	Society of Motion Picture Television Engineers
DIN	www.din.de	German Standards Institute
EBU	www.ebu.ch	European Broadcasting Union
AES	www.aes.org	Audio Engineering Society
ITU	www.itu.int	International Telecommunication Union

CONTACT DETAILS AND CUSTOMER SUPPORT

For any form of assistance in maintaining your Hamlet DS900, please contact:

Corporate Head Office

Hamlet Video International Limited

Maple House 11 Corinium Business Centre Raans Road Amersham Bucks HP6 6FB England

Main Line: +44 (0)1494 729 728

Fax Line: +44 (0)1494 723 237

Free phone (UK) 0500 625 525

E-mail: service@hamlet.co.uk Web site: www.hamlet.co.uk

Hamlet USA

Sencore, Inc.

3200 W Sencore Drive, Sioux Falls SD 57107, U.S.A.

Phone: (605) 339-0100

Fax: (605) 339-7032

Toll Free: 1-800-SENCORE (736-2673)

Toll Free: 1-866-4-HAMLET (426-538)

Email: service@sencore.com Web site: www.hamlet.us.com

In correspondence concerning this instrument, please quote the serial number, which you will find printed on the label at the back of the unit.

INTERNAL BATTERY FITTED

The Batteries and Accumulators (Placing on the Market) Regulations 2008 implement in the UK the Internal Market provisions of the European Parliament and Council Directive on Batteries and Accumulators and Waste Batteries and Accumulators 2006/66/EC.

In accordance with Regulation 7 of these regulations, information is provided on the battery specification and on its ready removal.

ACCESS

To access the battery, undo the fourteen posidriv screws on the top of the case and lift off the case lid. The battery is then immediately accessible and can be removed from the battery socket by hand, without any tools.

The battery type is CR2032 Lithium coin cell.

